

Interlock kit components

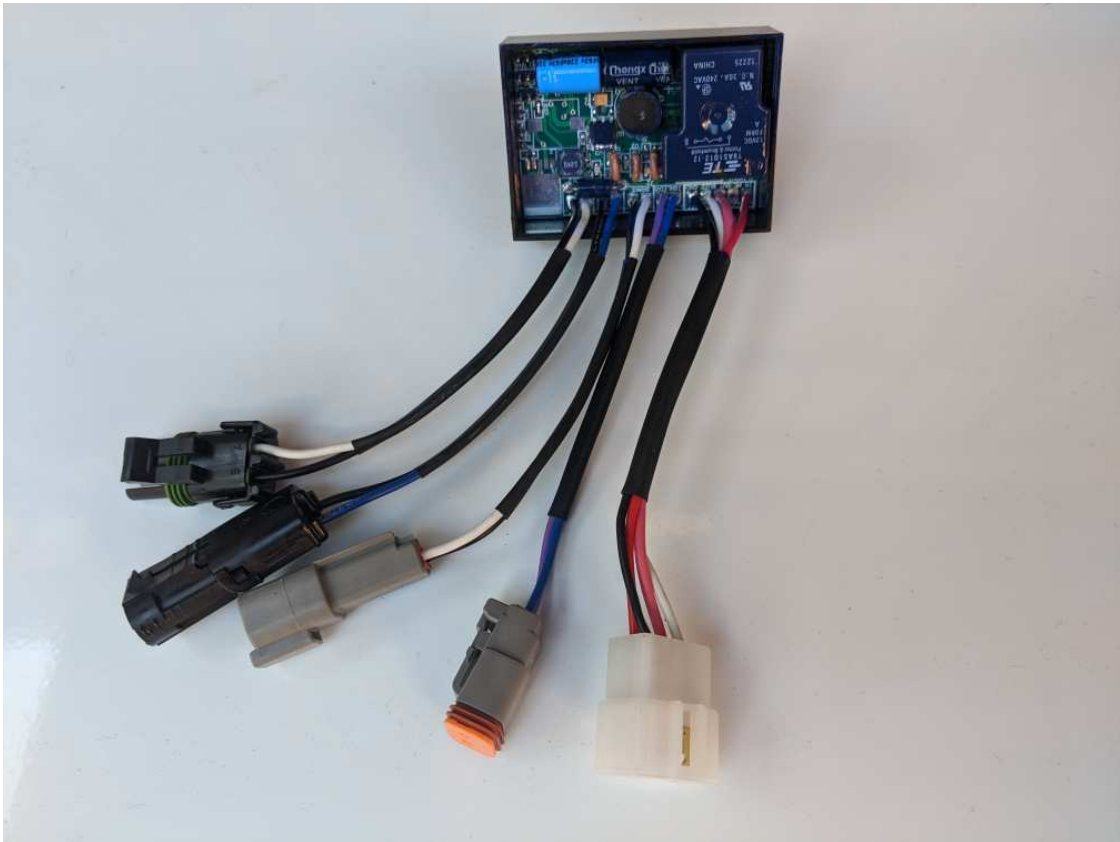

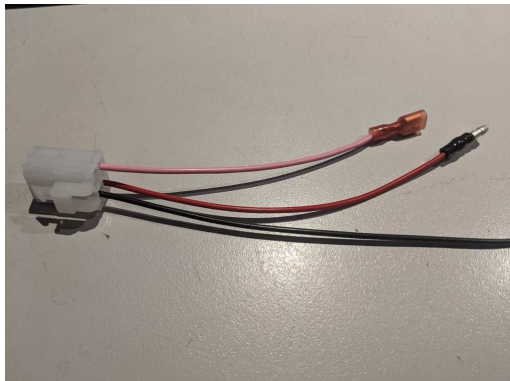

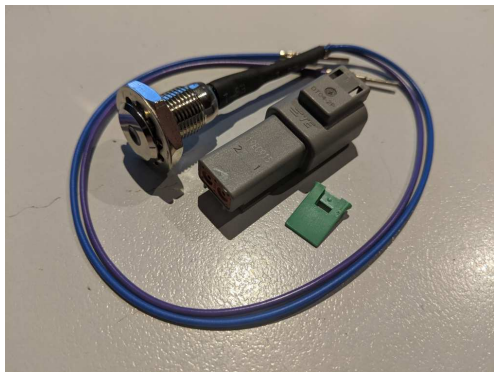

Mount the module on the left hand side of the firewall. There is an existing 12V female bullet connector. Connect the Red wire on the interlock power loom to this connector.



Existing 12V female bullet Connector

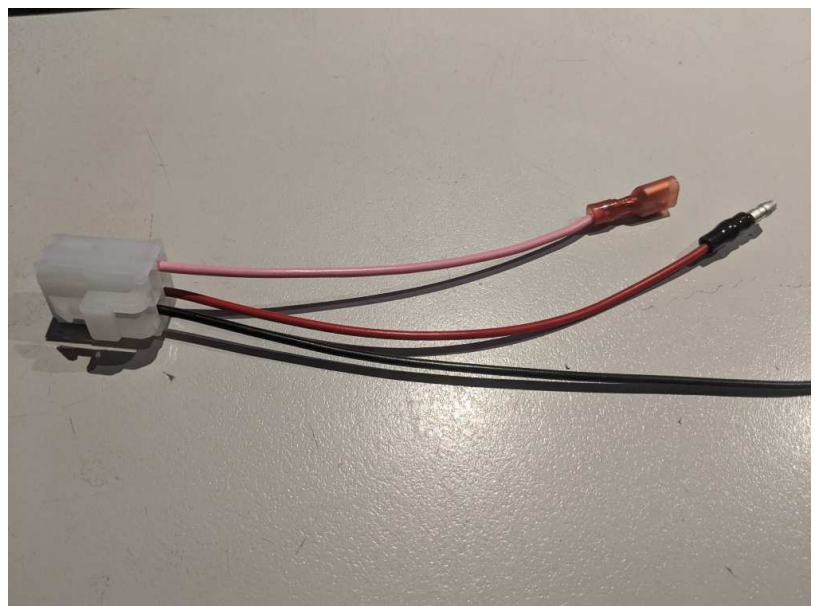

Interlock Power Loom

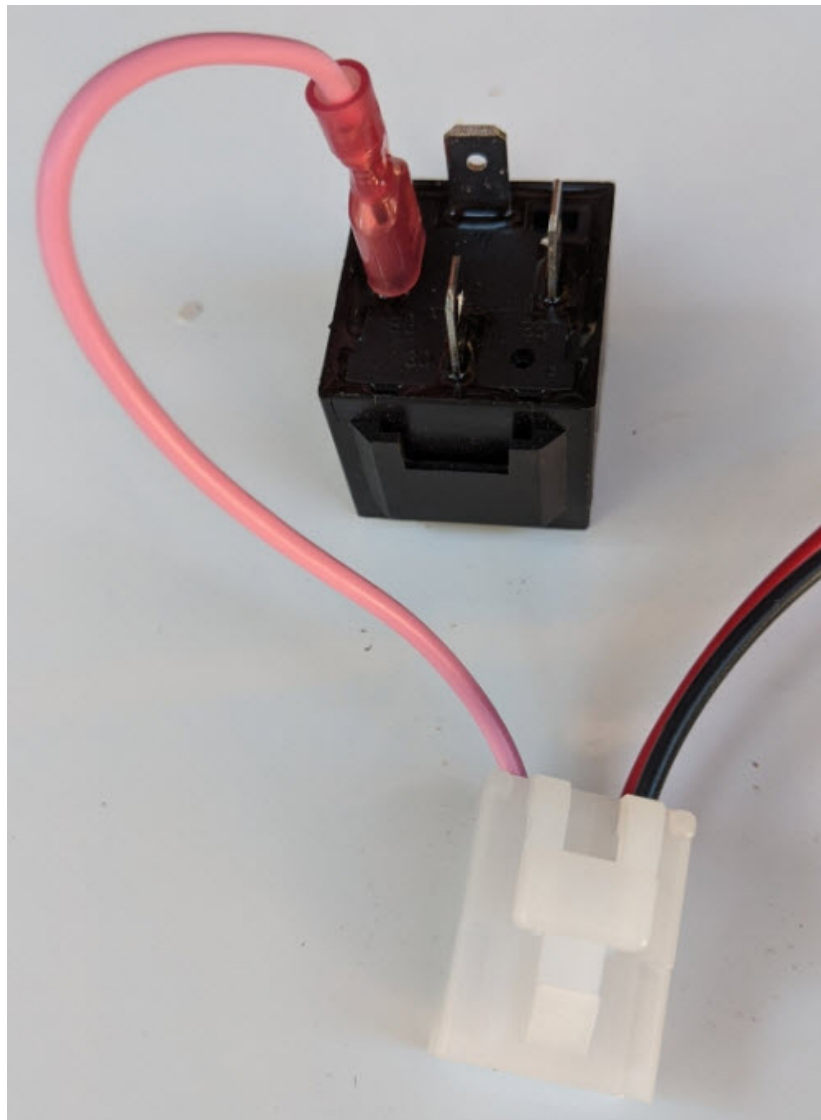

Connect the pink 12V 'output' from the Power Loom to pin 86 of the relay. Ground pin 85

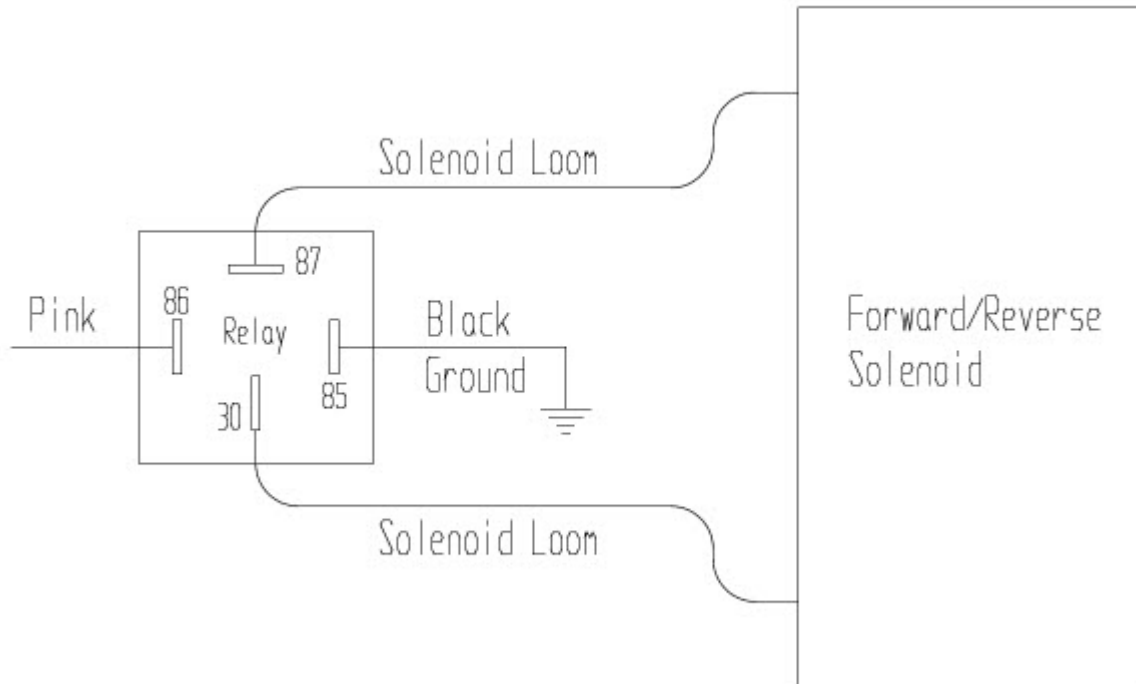

The solenoid loom connects directly to the solenoid connector and pins 30 and 87 of the relay





Mount power LED above in the plastic panel above the Interlock module





Mount brake microswitch using existing nut. Drill 3.5mm hole through sideplate and secure with 3mm screw.





Track Seat/Belt loom through truck chassis and up through Bonnet to attach to seat switch and seat belt.

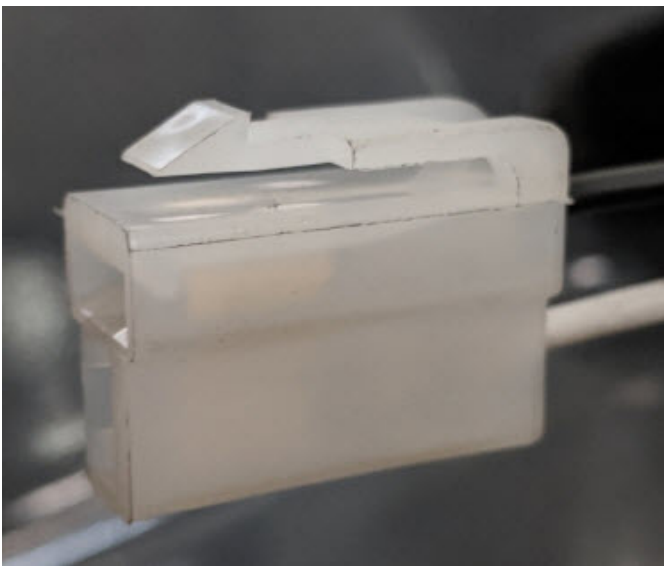

Seatbelt connector

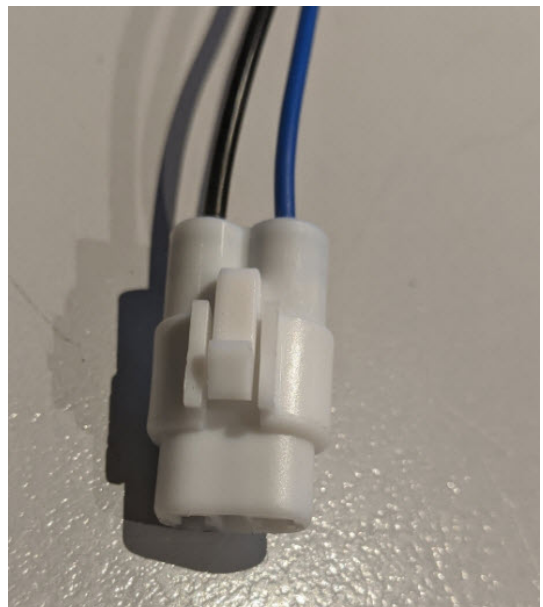

Seat switch connector